

Description:

- 20 gauge, 18-10 stainless steel, type 304
- **Two equal size bowls** - 16 x 14, 7" deep (41 x 36 cm, 18 cm deep)
- **Overall size** - 20 1/2 x 31 1/4, 7" deep (52 x 79, 18 cm deep)
- Rear drain location
- Self-rimming with faucet ledge and lower centre bar to avoid spillage
- Brush finished bowls, mirror finished rim



Recommended cabinet size:

- 33"

Faucet hole drilling:

- 3 holes - 1 1/2" diameter, 4" centre-to-centre (EDL2031/7/3)
- 4 holes - 4th hole on right hand side (EDL2031/7/4)
- 1 hole on centre (EDL2031/7/1)

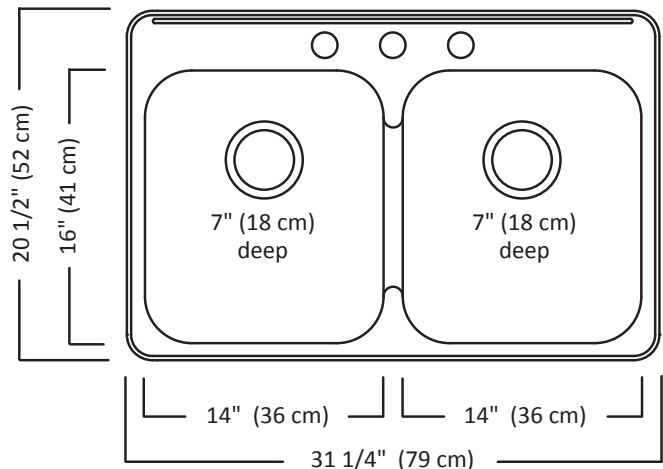

Inclusions:

- Basket Strainer (EA-114)
- Undercoating and sound deadening pads
- Template
- Hold-down clips
- All sinks individually boxed

Optional:

- Stainless steel bottom grid with rubber feet

Certifications:

- All product CUPC certified by IAPMO excepting strainers which are certified by CSA



Bottom Grid
EBGD1614



Bottom Grid
EBGD1614