

## Description:

- 18 gauge, 18-10 stainless steel, type 304
- **Bowl size** - 17 x 18, 8" deep  
(43 x 45, 20 cm deep)
- **Overall size** - 19 x 20, 8" deep  
(48 x 50, 20 cm deep)
- 10 mm radius corners
- Rear drain location
- Creased lines on bottom to improve drainage
- Satin bowl and ledge

## Recommended cabinet size:

- 24"

## Inclusions:

- Basket strainer: EA-114
- Undercoating and sound deadening pads
- Template
- Installation clips
- All sinks individually boxed

## Optional Accessories:

- Stainless steel bottom grid with rubber feet: **EBGF1718**
- Stainless steel roll mat with silicone wrapped bars: **ERM1914**
- Hardwood cutting board: **ECB1910**
- **Reference document available:**  
*Excalibur Sink Cross Reference to Accessories*

## Certifications:

- Sinks CUPC certified by IAPMO, strainers certified by CSA

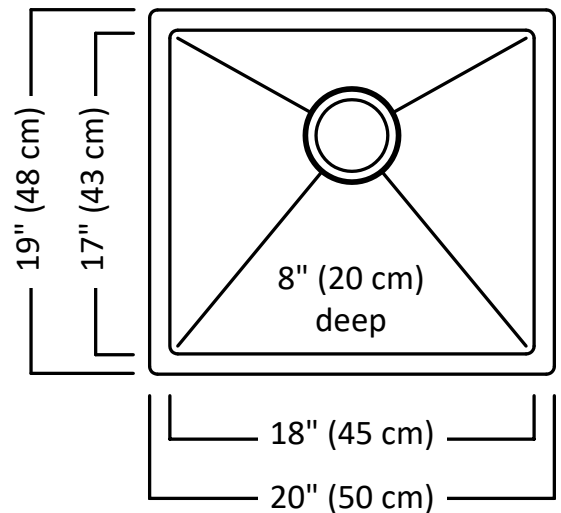

ECB1910  
Cutting Board

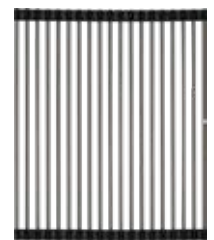

ERM1914  
Roll Mat

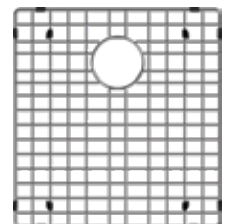

EBGF1718  
Bottom Grid

