

Description:

- Large Bowl Max Sink
- 18 gauge, 18-10 stainless steel, type 304
- **Bowl size** - 17 x 24, 8" deep
(43 x 61, 20 cm deep)
- **Overall size** - 19 x 26, 8" deep
(48 x 66, 20 cm deep)
- 10 mm radius corners
- Rear drain location
- Creased lines on bottom to improve drainage
- Satin bowl and ledge

Recommended minimum cabinet width:

- 30"

Inclusions:

- Basket strainer: EA-114
- Undercoating and sound deadening pads
- Template
- Installation clips
- All sinks individually boxed

Optional Accessories:

- Stainless steel bottom grid with rubber feet: **EBGF1724**
- Stainless steel countertop roll mat with silicone wrapped bars: **ERM1914**
- Hardwood countertop cutting board: **ECB1910**
- **Reference document available:**
Excalibur Sink Cross Reference to Accessories

Certifications:

- Sinks CUPC certified by IAPMO, strainers certified by CSA

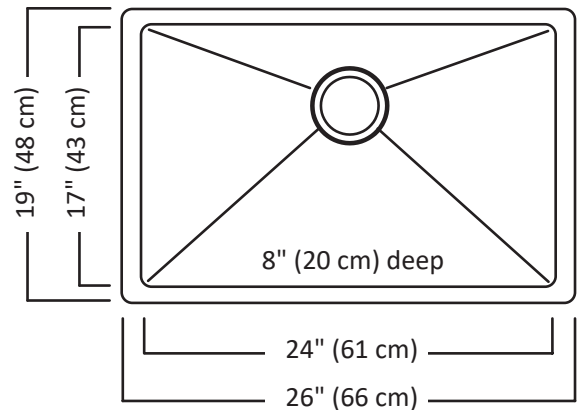

ECB1910
Countertop
Cutting Board

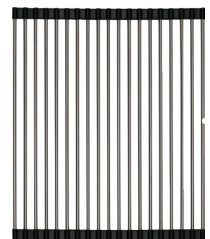

ERM1914
Countertop
Roll Mat

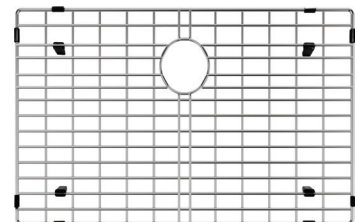

EBGF1724
Bottom Grid

