

Description:

- 18 gauge, 18-10 stainless steel, type 304
- **Large bowl** - 16 x 14, 9" deep
(41 x 35, 23 cm deep)
- **Small bowl** - 16 x 10, 9" deep
(41 x 25, 23 cm deep)
- **Overall size** - 18 x 27, 9" deep
(45 x 69, 23 cm deep)
- 10 mm radius corners
- Rear drain location
- Flush divide centre separation
- Creased lines on bottom to improve drainage
- Satin bowl and ledge

Recommended cabinet size:

- 33"

Inclusions:

- Basket strainer: EA-114
- Undercoating and sound deadening pads
- Template
- Installation clips
- All sinks individually boxed

Optional Accessories:

- Stainless steel bottom grid with rubber feet:
Large bowl **EBGF1614**, Small bowl **EBGF1610**
- Stainless steel roll mat with silicone wrapped bars: **ERM1814**
- Hardwood cutting board: **ECB1810**
- **Reference document available:**
Excalibur Sink Cross Reference to Accessories

Certifications:

- Sinks CUPC certified by IAPMO, strainers certified by CSA

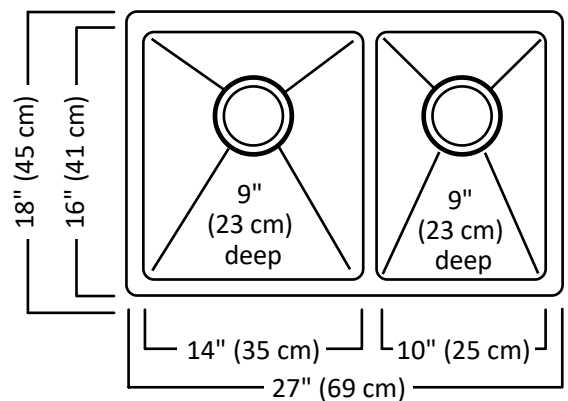

ECB1810
Cutting Board

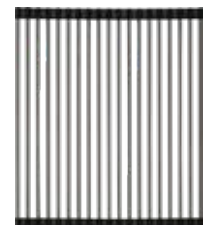

ERM1814
Roll Mat

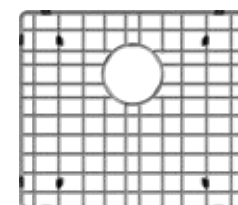

EBGF1614
Bottom Grid

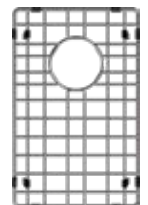

EBGF1610
Bottom Grid

