

## Description:

- 18 gauge, 18-10 stainless steel, type 304
- **Large bowl** - 16 x 14, 9" deep  
(41 x 35, 23 cm deep)
- **Small bowl** - 16 x 10, 9" deep  
(41 x 25, 23 cm deep)
- **Overall size** - 18 x 27, 9" deep  
(45 x 69, 23 cm deep)
- 10 mm radius corners
- Rear drain location
- 2" low divide centre separation
- Creased lines on bottom to improve drainage
- Satin bowl and ledge

## Recommended cabinet size:

- 30"

## Inclusions:

- Basket strainer: EA-114
- Undercoating and sound deadening pads
- Template
- Installation clips
- All sinks individually boxed

## Optional Accessories:

- Stainless steel bottom grid with rubber feet:  
Large bowl **EBGF1614**, Small bowl **EBGF1610**
- Stainless steel roll mat with silicone wrapped bars: **ERM1814**
- Hardwood cutting board: **ECB1810**
- **Reference document available:**  
*Excalibur Sink Cross Reference to Accessories*

## Certifications:

- Sinks CUPC certified by IAPMO, strainers certified by CSA

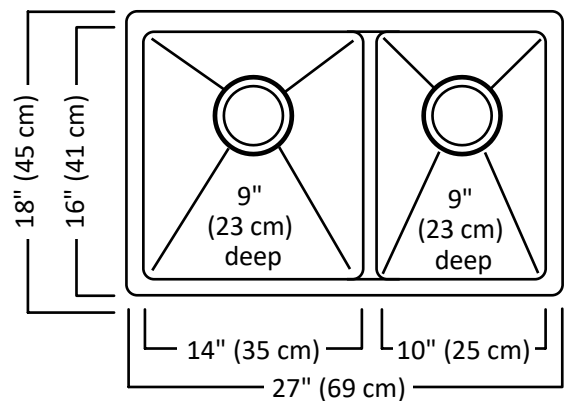

ECB1810  
Cutting Board



ERM1814  
Roll Mat

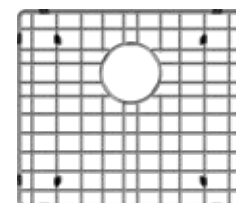

EBGF1614  
Bottom Grid

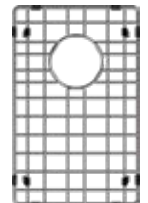

EBGF1610  
Bottom Grid

